



FETTEC KISS FC Firmware Mini AIO 15A User Manual

[Home](#) » [FETTEC](#) » FETTEC KISS FC Firmware Mini AIO 15A User Manual 

Contents

- [1 FETTEC KISS FC Firmware Mini AIO 15A](#)
- [2 Introduction](#)
- [3 Features](#)
- [4 Dimensions](#)
- [5 Connection Diagram](#)
- [6 FC firmware update](#)
- [7 OSD firmware update](#)
- [8 Issues with the OSD](#)
- [9 Documents / Resources](#)
 - [9.1 References](#)
- [10 Related Posts](#)



FETTEC KISS FC Firmware Mini AIO 15A

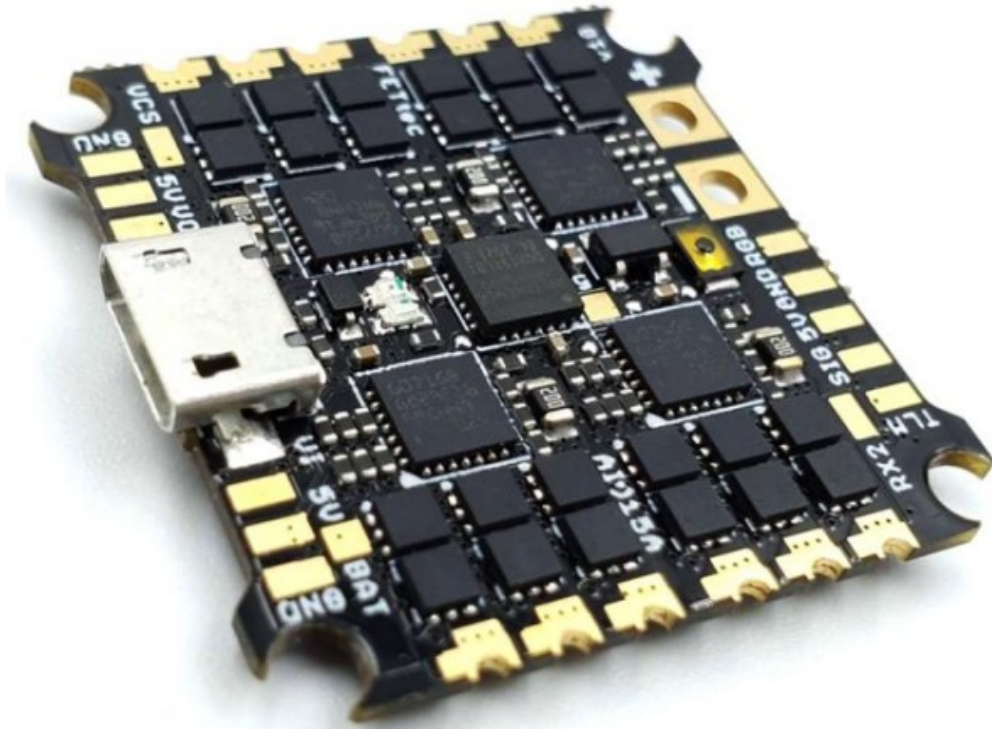

Introduction

Thank you for purchasing the FETtec Mini AIO 15A.

Features

FC:

- KISS FC firmware
- F3 Processor (STM32F303CCT6 @ 72MHz (MPU6000))
- Supply voltage 6-18V (2S-4S Lipo voltage)
- Dedicated onboard 5V BEC (max 1A)

ESC:

- Active current limiting @ 15A
- Input voltage: 2S-4S
- High quality 30V MOSFETs
- STM32G071 @ 64MHz
- 128 kHz Motor PWM
- Automatic input signal detection
 - Dshot 300-2400
 - PWM
 - OneShot42/125

OSD:

- Graphic OSD (STM32)

- Full KISS Tuning
 - Filter (PIDs, Rates, Settings)
 - LED control (RGB LED, Racewire)
 - VTX
 - Live data graphs (Voltage, motor rpm, current, motor temp, gyro values, link quality)
 - KISS GPS support + live map
 - Custom graphic pilot logo
 - Stick overlay
 - Custom layout

The FETtec Mini AIO 15A works with KISS/FETtec FC firmware version 1.3RC45Y or later !

Safety warning

Remove propellers before flashing and configuration

Dimensions

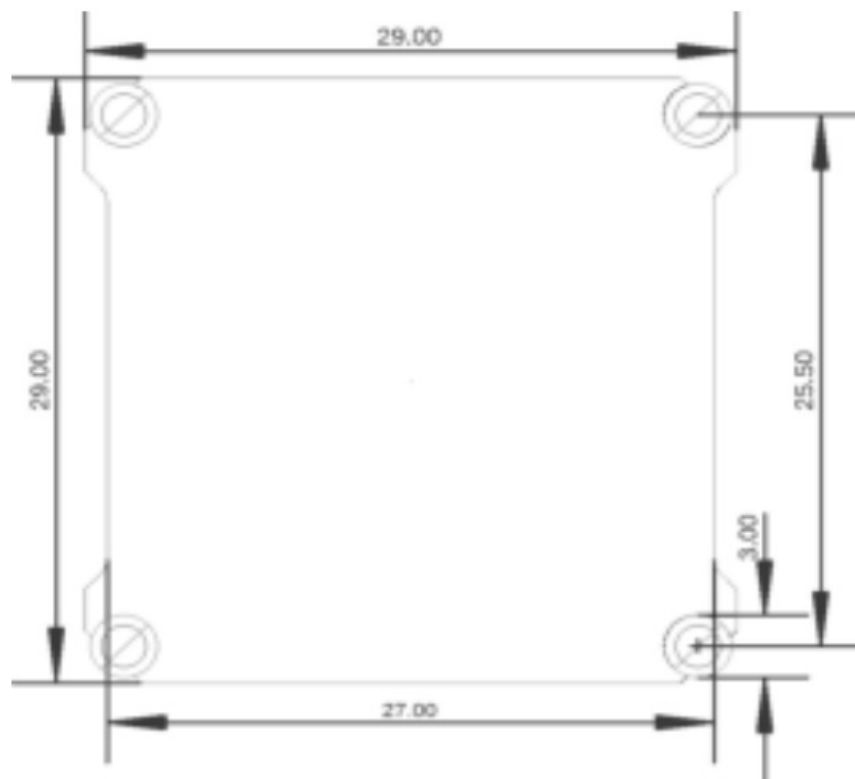

Dimensions: 29 x 29 mm

Weight: 3,41 g

Connection Diagram

Top-/Bottom Layout

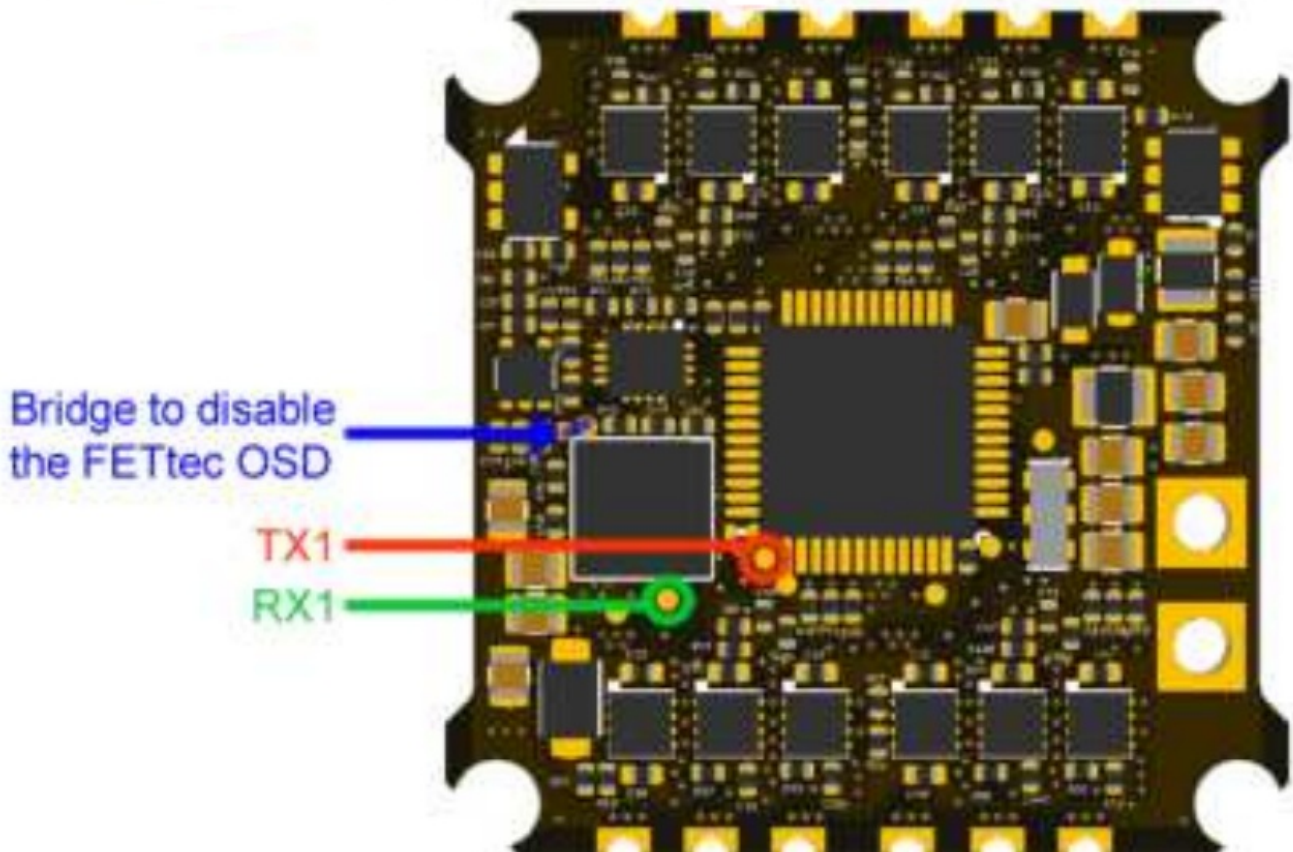
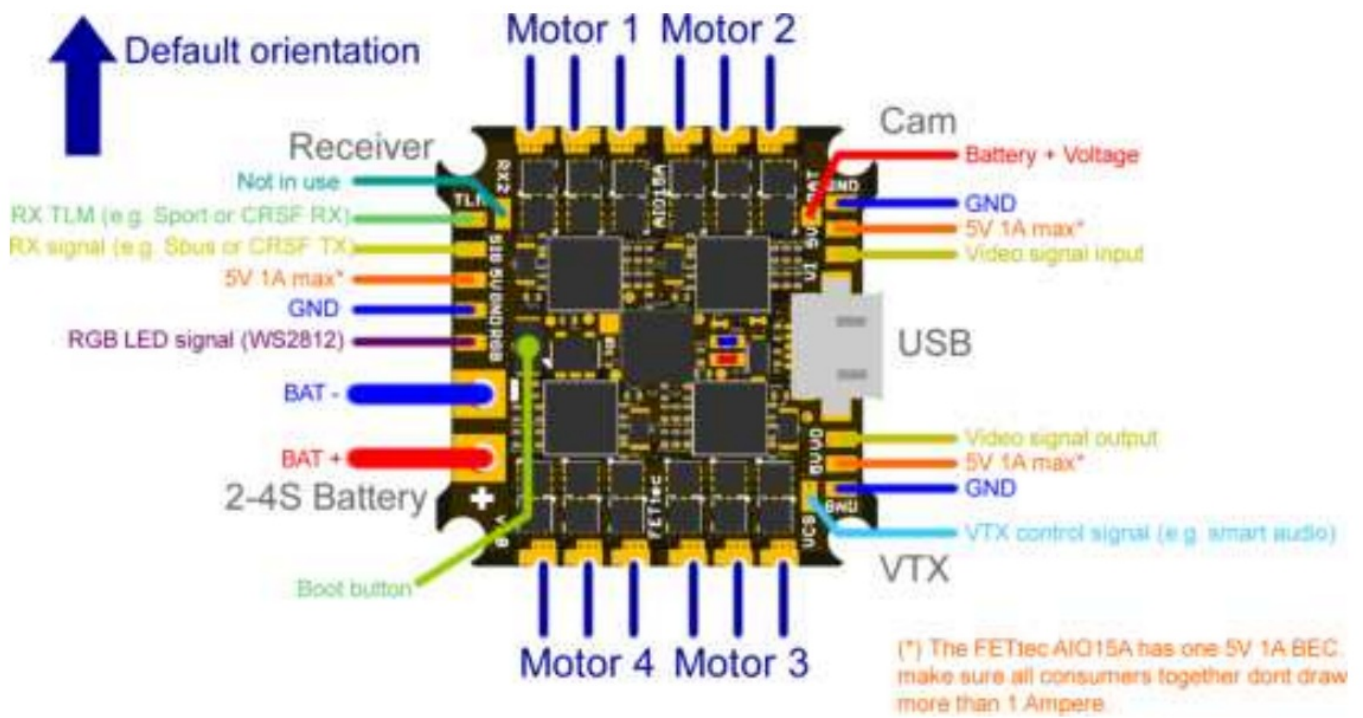

The FETtec Mini AIO 15A has 3 UARTs in the following assignment
 UART 1: Onboard FETtec OSD or others in case you use the bridge (for DJI Unit e.g.)
 UART 2: RX
 UART 3: VTX control (smart audio) + ESC telemetry

FETtec Configurator

Please update the FETtec Mini AIO 15A before your first flight !

The FC, ESC and OSD of the FETtec Mini AIO 15V Board are flashable over the FETtec Configurator.

The FETtec Configurator is available for download at <https://github.com/FETtec>.

FC firmware update

- choose USB and connect.

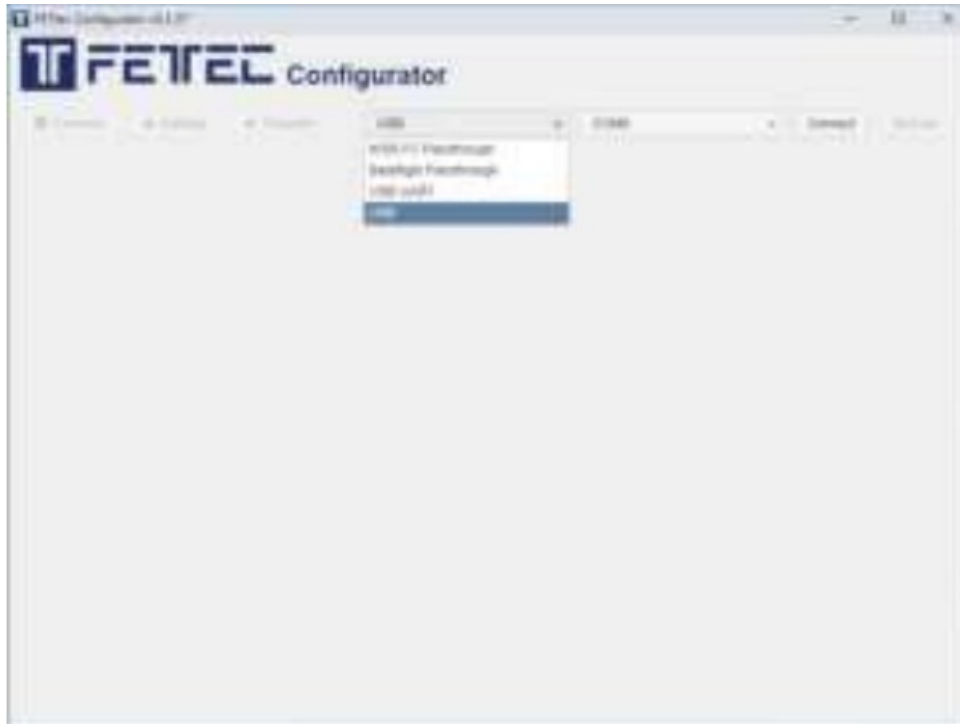

- FETtec F3 Nano-FC will be found.
Use Remote Firmware and select the newest available firmware.

Press "Flash selected"

This will take some time, please wait.

FC is flashed now!

Settings can be made in the KISS GUI.

Download:

<https://github.com/flyduino/kiss-gui/releases>



- Choose KISS FC Passthrough and press connect.



- all devices are shown now
The Overview page allows to flash individual ESCs.

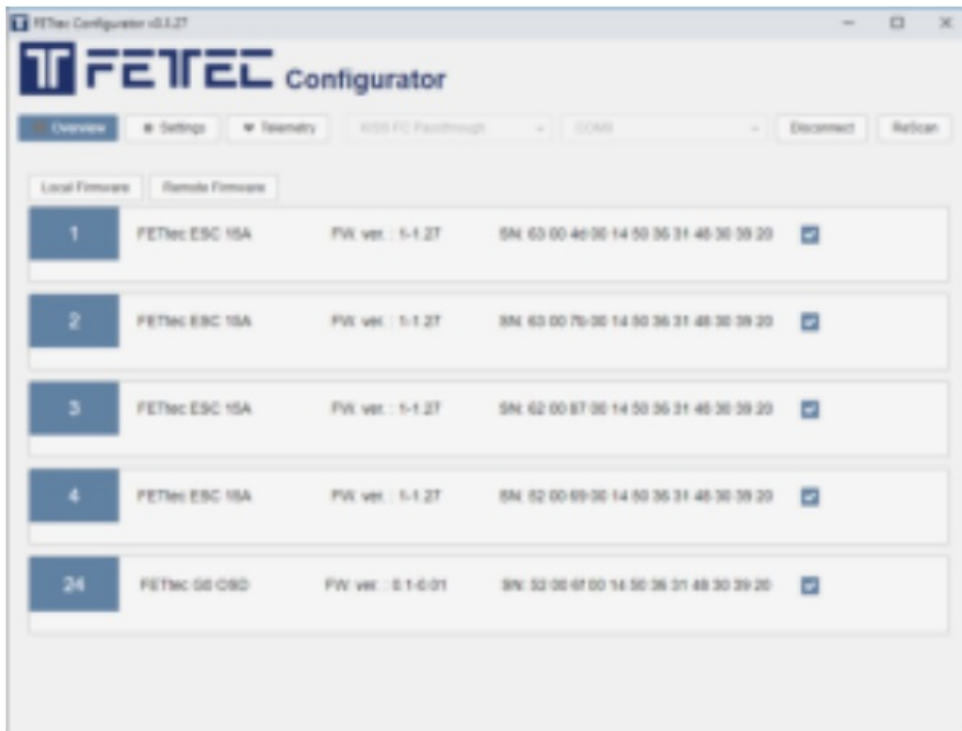

- The Setting page allows to adjust all available ESC parameter.



- Reverse rotation direction
- Slow start
- 3D mode
- PWM min & max signal
- ESC Beep enabled
- Current calibration
- Individual ESC ID (for use on onewire protocol)

In the Telemetry page you can spin the motors, view and debug the motor telemetry.



OSD firmware update

To update the OSD, connect to FETtec Configurator and flash the latest firmware via FC Passthrough.



OSD Settings

All settings are to set directly in the OSD. To get in the menu move the sticks in the shown direction at the start:
Throttle 50%, then move Yaw left, Pitch up

Mode 1:

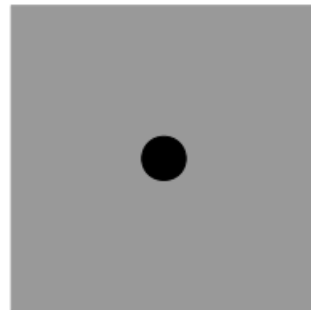

Mode 2:

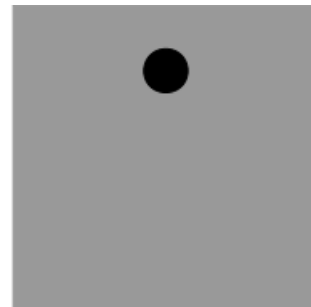
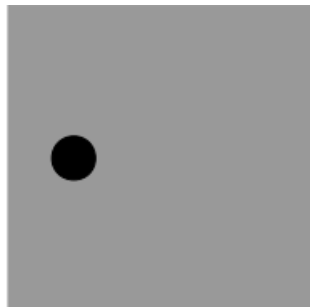

OSD menu:



OSD settings:



Issues with the OSD

1. OSD SYNC → AUTO SYNC
2. in case of blurry lines play with LEFT/WITH values try to avoid WITH values above 400
3. make a PAL/NTSC layout reset

Move elements in the OSD menu

Choose LAYOUT → SET POSITIONS in SETTINGS.

Now the elements are movable along the grid. Skip between the elements and select them to set new positions.

To exit the ´move menu´ hold stick Yaw left for a few seconds

Documents / Resources

 <p>FETtec Mini AIO 15A Manual</p>	<p>FETTEC KISS FC Firmware Mini AIO 15A [pdf] User Manual KISS FC Firmware Mini AIO 15A, Mini AIO 15A, KISS FC Firmware, AIO 15A</p>
---	--

References

- [FETtec · GitHub](#)
- [GitHub - FETtec/Firmware: FETtec ESC Firmware repository](#)
- [Releases · flyduino/kiss-gui · GitHub](#)

[Manuals+](#).